

ATLET ERGO STAND-ON STACKER

AJN/ASN

ERGONOMIC STAND-ON STACKERS FOR INTERNAL TRANSFERS AND
STACKING IN WAREHOUSES, STORES AND PRODUCTION PREMISES



ATLET

The Atlet Ergo Stand-On Stacker is the ideal truck solution for warehouse and production. Cost-effective, ergonomic, and reliable.



ATLET ERGO STAND-ON STACKER -THE IDEAL TRUCK SOLUTION

THE STAND-ON STACKER CONCEPT

Atlet launched the Stand-On Stacker back in 1961. At the time its radical and cost-effective thinking represented a new trend in internal materials handling.

Ever since then the Stand-On Stacker has been the ideal truck for standard warehouses, stores and production supplies.

The idea behind it:

The most cost-effective warehouse – 7-metre ceiling height, 6 pallet positions high and an aisle width of 2.3 metres.

The most space-saving truck – minimal dimensions, tightest turning radius and a well-protected driver.

More effective ergonomics – a stand-on driver is mobile and more active. Less risk of strain injuries.

More reliable operation – the Stand-On Stacker is simple and very robustly built, with a high operating capacity.

MOST PALLET POSITIONS

If you want a well-utilised, cost-effective, standard warehouse, with palletised goods, you should choose the Atlet Ergo Stand-On Stacker.

You can have a racking height of 6 metres and, for example, a beam spacing of 1.2 metres, which gives storage 6 pallets high. Aisle width 2.3 metres. Then you have a warehouse capacity of 2.5 pallet positions per m². In other words, no less than 1 250 pallet positions on 500 m².

That is fully 415 pallet positions more than in a warehouse based on handling with pedestrian stackers. The pedestrian stacker gives a capacity utilisation of 1.67 positions per m².

STAND-ON STACKER 2.5 PALLET POSITIONS/M²

PEDESTRIAN STACKER 1.67 PALLET POSITIONS/M²

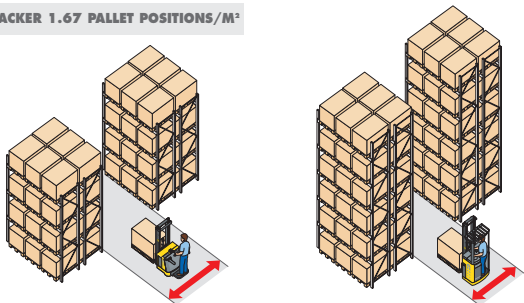

33% LOWER COST PER PALLET POSITION

How crucial is it to optimise the warehouse space? Comparing the Stand-On Stacker again with a warehouse designed for Pedestrian Stackers, you save € 11 per pallet position per year!

The cost is € 33 for the Pedestrian Stacker and € 22 for the Stand-On Stacker, if the rental cost is € 55 per m² per year. In percentage terms your stand-on stacker warehouse is 33% cheaper.

THE DRIVER PRODUCES MORE

Walking, standing or sitting driver? It is interesting to note that a driver who drives an Atlet Ergo Stand-On Stacker works efficiently and more ergonomically than one on a truck that he walks behind or sits on.

Walking driver: 25% longer travelling time over a distance of 25 metres. Furthermore – inefficient to have a walking operator on ergonomic grounds.

Sitting driver: Less efficient working position. A sideways-on driver risks stress injuries as the sitting position is locked.

Atlet Ergo Stand-On Stacker: Intended for 2-5 hours' driving per shift. Frequent getting on and off with one neat step to the floor. The driver is protected in every situation, which improves working performance.

MORE OPERATING TIME

With its simple and robust construction the Atlet Ergo Stand-On Stacker gives more hours of reliable operation. Small number of components and high technology reduce problems and extend intervals between servicing.

Advanced operating technology with computerised AC motor and electric servo. Programmable performance.

THE ATLET ERGO STAND-ON STACKER LEAVES THE DRIVER IN SAFE HANDS

An unprotected driver risks injury from crushing. The accident statistics are alarmingly high for pedestrian stackers, with leg and foot injuries the most frequent.

The illustrations show the versatility, minimal space requirement and safety of the Atlet Ergo Stand-On Stacker compared with a Pedestrian Stacker.

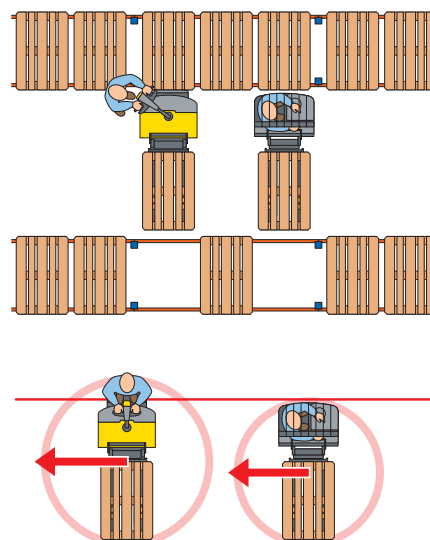

In production environments the stand-on stacker is superior to other types of trucks thanks to its versatility and small turning circle. Double pallet handling also gives more efficient cycles.

Speed- and hydraulic controls of the truck are simple. Fingertip servo control also contributes to the speed and high precision of every movement.

Acceleration and braking in a single control. The brake function is of similar type to that for the Atlet Tergo Reach Truck. The motor retards and at the same time feeds energy back to the battery.

P/D, BDI and error messages are shown on a digital display.



The Atlet Ergo Stand-On Stacker has been created to give the driver the best possible ergonomics.

The position of the wheel is changed instantly between two positions to give the most ergonomic position for driving forwards or backwards.

Tall driver or short. Anyone can have a comfortable driving position, thanks to the vertically adjustable armrest and control panel.



FLEXIBLE ERGONOMICS TO SUIT EVERY DRIVER

When Atlet was developing the Ergo Stand-On Stacker, a test group of people was created to evaluate and maximise the ergonomic aspects of the design. Three drivers of differing physique, all needing to be able to drive and use the truck in the best manner possible. Studies, interviews and measurements continued for several years.

TALL, SHORT, BIG

Tall, short, big. The Atlet Ergo Stand-On Stacker suits everyone, thanks to its flexible ergonomics.

The Atlet Ergo Stand-On Stacker is a truck for intensive and varied handling, often involving shift work. Every driver can therefore quickly and simply set his own ergonomic ideal. The arm and hand support can be adjusted in height (25 cm) and angle (30°). The wheel slides to a comfortable driving position.

ERGONOMIC FOR THE DIRECTION OF TRAVEL

Being able to stand comfortably facing in the direction of travel – not having to strain the body and head with incorrect twisting movements – is an important ergonomic factor. So the wheel can be quickly slid between a forward/reverse

position to let the driver face the way the truck is going. The floor-mounted “dead man’s pedal” is positioned to allow variation in standing position. The pedal also acts as an emergency and parking brake. The floor is shaped to give extra foot room.

SERVO-LIGHT

Steering and controls are servo-assisted. Fingertip control with extremely high precision. A standing driver can make better use of these characteristics. The body is freer and the driver can be more active.



ROOM FOR PAPERS

A spacious and comfortable working position with a large writing surface, storage box and waste paper bin. As standard the panel is fitted with a recess for a can or cup. Choice of positions for radio, computer, code reader etc.

SPRUNG FLOOR AND LOW STEP

The Atlet Ergo Stand-On Stacker is suitable for continuous work up to 5 hours and driving distances of up to 100 metres. Industrial floors are often uneven and joints are felt throughout the truck. Atlet has solved this with a specially designed truck floor that cushions and absorbs impacts. The floor is suspended on rubber pads and has resilient soft matting. The floor area has been enlarged with extra foot room to allow the driver to get closer to the controls and makes it easier to change his or her position. The step is very low to make frequent mounting and alighting easier.





Warehouse utilisation, pallet position cost, driver efficiency and operational reliability are the factors that determine the total operating cost.

The Atlet Ergo Stand-On Stacker offers the optimum truck solution at the lowest cost for handling and storage of standard euro-pallets. The largest model can stack 2000 kg to 5.4 metres and 1600 kg at 6.3 metres.

The aisle width required is as little as 2.3 metres.

Driving speed is programmable: max. speed 12 km/h. Lifting speed 0.3 m/sec, which is very quick.

Stabilisers for lift heights of over 4 metres increase the support base by 50%.

TRANSFER, WAREHOUSE AND PRODUCTION PREMISES

The Atlet Ergo Stand-On Stacker is the most efficient and dependable truck for material supply in production environments.

Raw material supplies can be kept low. Transfer to P/D stations is achieved smoothly using a minimum of space. The driver never risks trapped hands or feet and can therefore work more efficiently.

Travel speed is programmable to suit the circumstances. The possibility of carrying two pallets optimises materials flow and empty-pallet handling.



BUILT FOR RELIABLE AND PROBLEM-FREE OPERATION

Safety has two levels. There is the driver's safety and the environment and the safety, or reliability of operation. Accidents and ergonomic risks are avoided by better performance and more accurate manoeuvring. The performance of the truck should be adjustable to the circumstances of the working environment. A high level of utilisation of the truck requires quality and reliable operation.

ADJUSTABLE PERFORMANCE

The Atlet Ergo Stand-On Stacker has 30 adjustable parameters. The performance is pre-set on delivery, but Atlet's service engineers can adjust the truck performance to suit the particular circumstances of the individual place of work.

Important: the Atlet Ergo Stand-On Stacker has the capacity to reduce acceleration automatically at steering angles of over 45°, and to reduce driving speed for heavy goods, or for handling at high levels.

50% LARGER STABILITY BASE

Outriggers are lowered at lift heights of over 4 metres. The Atlet Ergo Stand-On Stacker can have outriggers even when it is fitted with straddle lift.

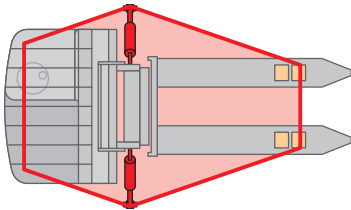

DOUBLE PALLETS

Handling efficiency increases dramatically if straddle lift is chosen. This makes it possible to carry two pallets. Both straddles and forks are used. The straddles can carry a load of 1600 kg. This also facilitates empty-pallet handling, which can be included in the same handling cycle. The truck can also be used for line-picking with a picking pallet on the straddles and a relief pallet on the forks.

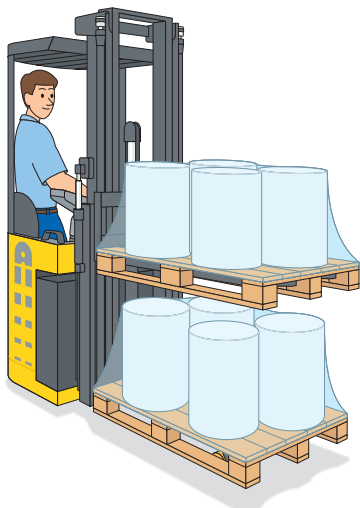

24-VOLT AC MOTOR

The drive motor gives 2kW output as standard. A power pack that permits rapid acceleration. 24-volt AC drive reduces wear generally. Reliable gear transmission. At the same time the motor exerts a braking effect and returns energy to the battery.

The lift motor is of DC type in three versions: 3.5kW, 4.5kW or 7.6 kW.

A "proportional valve" for the hydraulic system is an option which gives smoother running. Motors and electric system are easily accessible. This makes for quick and simple servicing.

A new type of charging plug and battery catch facilitate daily inspection.



CHOOSE TYPE AND POSITION OF MAST

The type of mast depends on the lift height and the weight of the goods. Standard free-view masts are mounted centrally on the chassis.

As an option there is a mast which can be shifted up to 5 cm to one side to give the driver different driving characteristics and a better view of pallets and handling movements.



ATLET ERGO STAND-ON STACKER

Atlet builds the widest range of stand-on stackers on the market, with 4 basic models and two models with telescopic forks.

*Telescopic forks permit high-density storage in double-depth racking.

A large selection of battery capacities enables the truck to be adapted to the operating conditions.

In the cold-store version the chassis is specially treated and motors, electronic equipment and batteries are protected against freezing.

Straddle lift is an optional extra.

Side stabilisers and side castors are options that enable the handling of heavier loads to heights over 4 m.

Atlet supplies a series of different forks, laterally adjustable, fork extensions and specially designed forks for particular requirements.

The straddles are available in a wide-track version for marine pallets, closed pallets etc.

The table below gives general guidance on the models and the equipment.

Detailed specifications are available on Atlet's web site www.atlet.com

MODEL	CAPACITY kg (max)	LIFT HEIGHT mm (max)	AISLE WIDTH mm	BATTERY Ah (max)	COLD STORE	STRADDLE LIFT	STABILISORS	SIDE CASTORS	TELESCOPIC FORKS
160 AJN	1600	5400	2300	450	✓	✓	✓	✓	
160 ASN	1600	6300	2450	750	✓	✓	✓	✓	
200 AJN	2000	5400	2350	450	✓	✓	✓	✓	
200 ASN	2000	6300	2500	750	✓	✓	✓	✓	
100 ATF* (ASN)	1000	5750	2485	750					✓
100 ATF* (AJN)	1000	5750	2370	450					✓

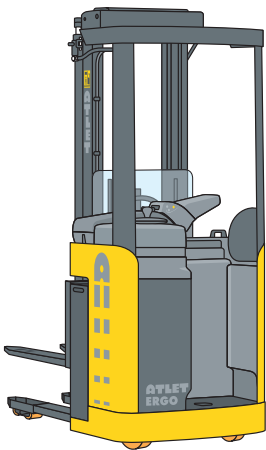

Atlet Ergo AJN/ASN

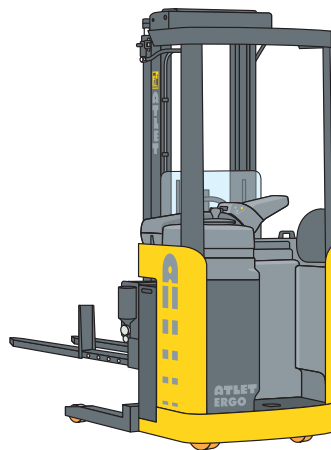

Atlet Ergo ATF

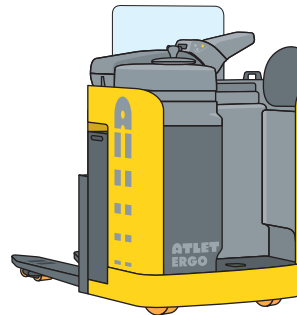

Atlet Ergo ALL

The Atlet Ergo ALL is designed for horizontal transportation.

The forks can be adapted for specific applications. The straddles can be lifted.

The Atlet Ergo ALL has the Ergo stacker's high ergonomic standard and driver safety.

ATLET

Atlet AB, S-435 82 Mölnlycke, Sweden
Tel: +46 31-98 40 00 Fax: +46 31-88 46 86
info@atlet.se www.atlet.com

ATLET Ltd., THAME Oxon OX9 3RR
Telephone: 01844 215501. Telefax: 01844 216492
www.atlet.co.uk.